

***PCB 1.6mm Thickness**

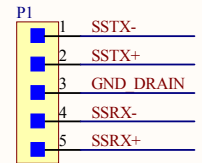
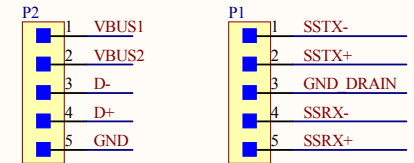
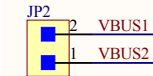
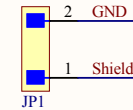
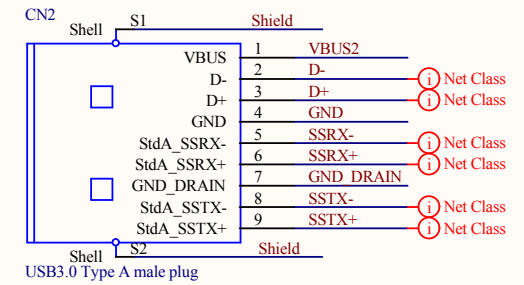
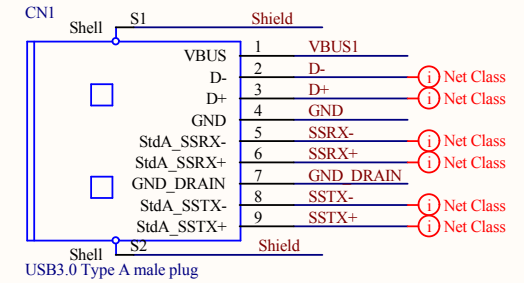
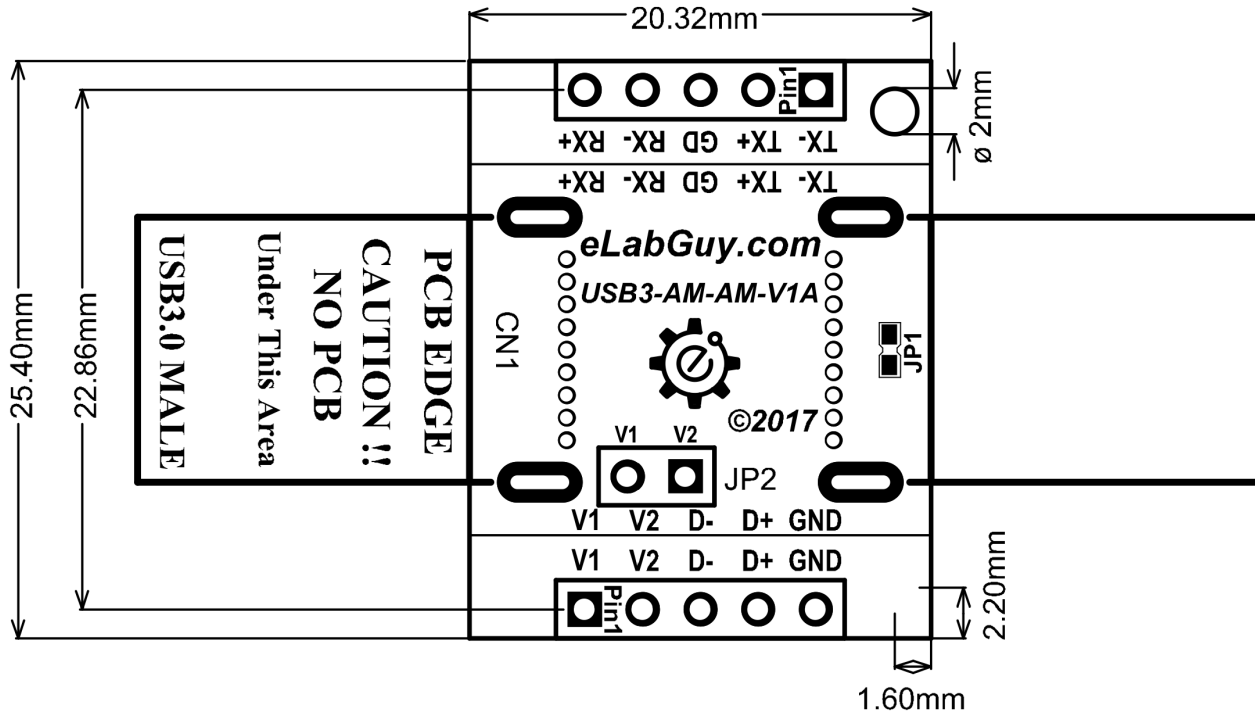

Header 2X1 _2.54mm

Header 5X1 _2.54mm

Header 5X1 _2.54mm



Title USB3.0 A Male To A Female Breakout		
Size A4	Number USB3-AM-AM-V1A	Revision 1A
Date: 10/8/2017	Sheet of	
File: C:\Users\...USB3-AM-AM-V1A Drawing SolidDoc By: www.eLabGuy.com		