

* PCB 1.60mm THICKNESS

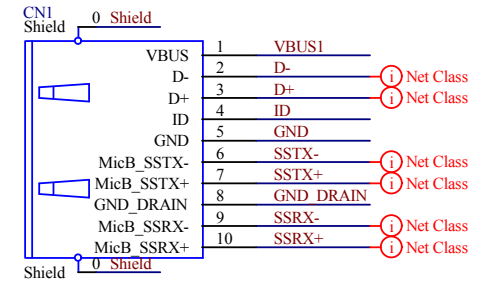

Micro USB3.0 Type B Female

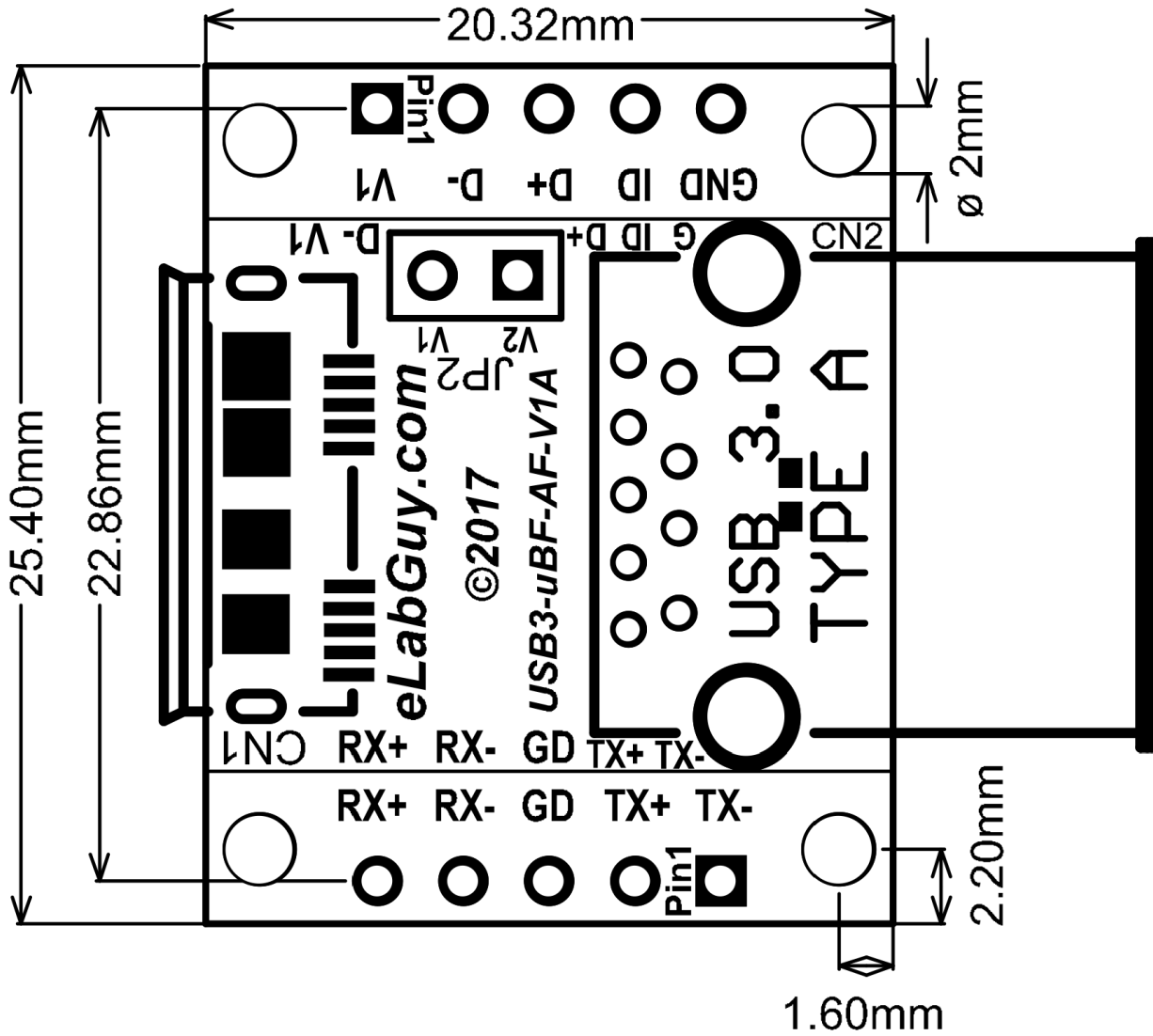
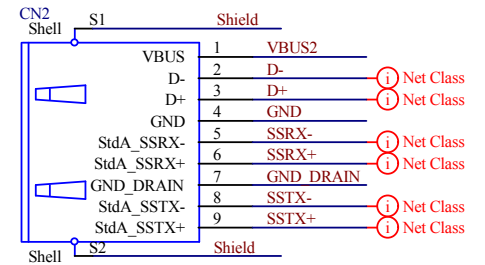

USB3.0 Type A Female

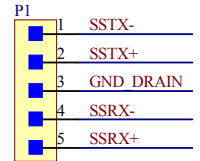
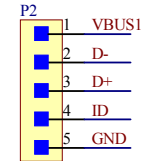
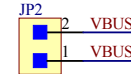
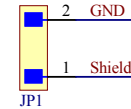

Header 2X1 _2.54mm

Header 5X1 _2.54mm

Header 5X1 _2.54mm



Title USB3.0 Micro B Female To Type A Female Pass Through		
Size A4	Number USB3uBF-AF-V1A	Revision 1A
Date: 11/30/2017	Sheet of	
File: C:\Users\...USB3-uBF-AF-V1A Drawing Sheet No. By: www.eLabGuy.com		