

* 0.8mm THICK FR4 (2 LAYER BOARD)

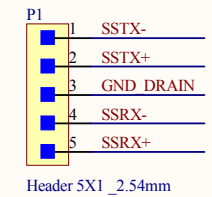
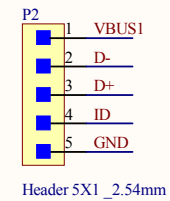
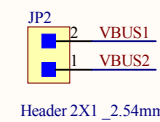
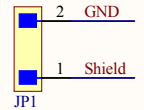
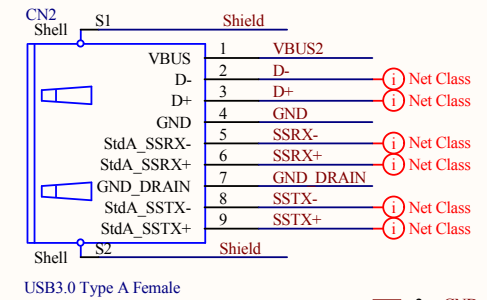
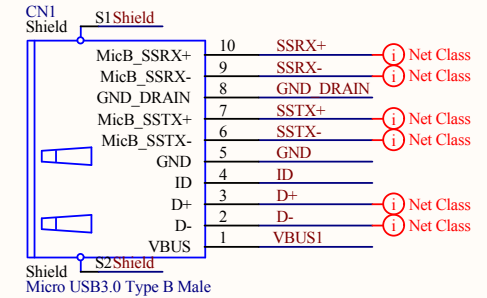
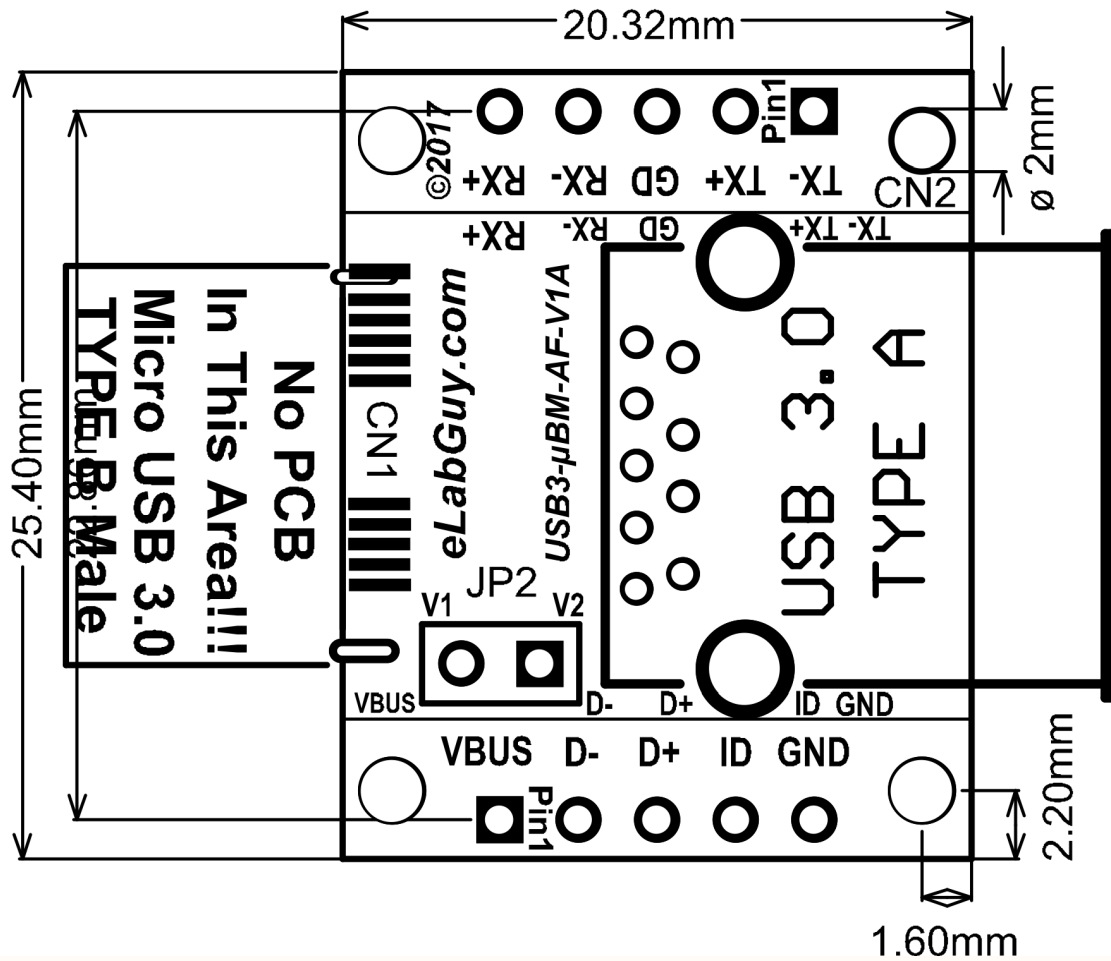

Title			USB3.0 Micro Type B Male to Type A Female Breakout		
Size	Number	Revision			
A4	USB3-µBM-AF-V1A	1A			
Date:	9/6/2017	Sheet of			
File:	C:\Users\...USB3-µBM-AF-V1A Drawing	SubDocBy:		www.eLabGuy.com	